





-  Cut view of metal plate
-  Plate Insulating block material [x1] piece (hard)
-  Combustion head insulation [x2] pieces (soft)

Vendor Notes:
 GTE500A & GT530 Series boiler door blank plate modifications – according to drawing.

1. Cut boiler door for burner head
2. Drill and tap door for burner mounting studs
3. Install studs, flat washer and locking washers on studs
4. All cuts to be free of burrs and sharp edges
5. No finishing required

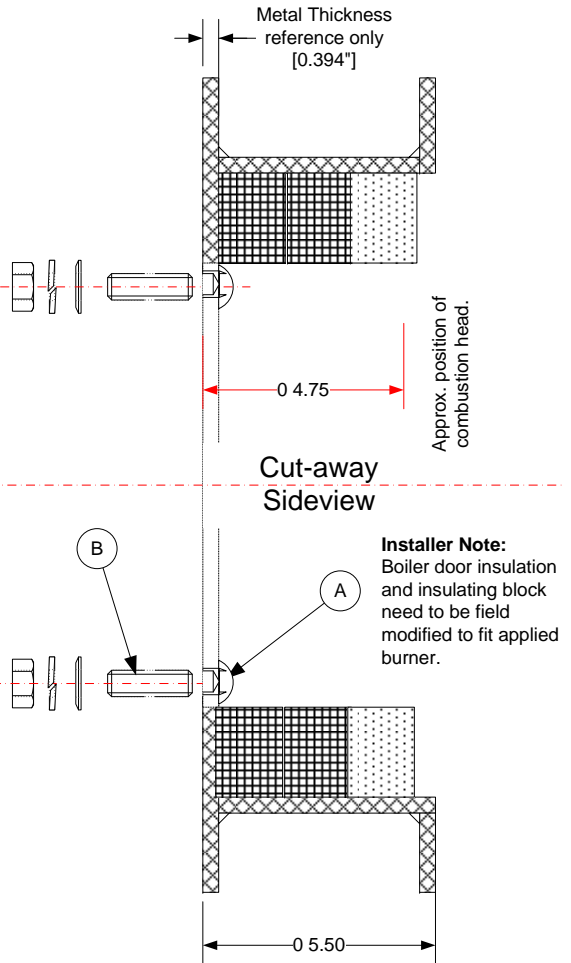

- Installer Note:**
 Boiler door insulation and insulating block need to be field modified to fit applied burner.
- (A)** Mounting stud holes to be reinforced at backing
 - (B)** Mounting Studs [x4] 5/8 inch- 18 NC X 2.0" steel grade 5 or equal

Drawing Template [0]	De Dietrich 		Description				OEM GTE 500A [GT530A series] burner mounting door modification for Industrial Combustion burner model V-VL-VLG 35-55	
	DDR Americas Inc. 1090 Fountain Street North, Unit 10 & 11 Cambridge, Ontario N3E 1A3 – Canada Tel: 1.800.943.6275 Fax: 519.650.1709 Website: www.dedietrichboilers.com		Creator	Craig H.	Tolerances ±	0.03"	Material	8259-0538
			Approved		Scale	3" = 1 ft.	File Name	2-500-ICB-002a
			Revision	0	Units	Inches	Date [mm/dd/yy]	04/30/08

Industrial Combustion Size 2 V35-55 VL-VG-VLG burner – burner flange details

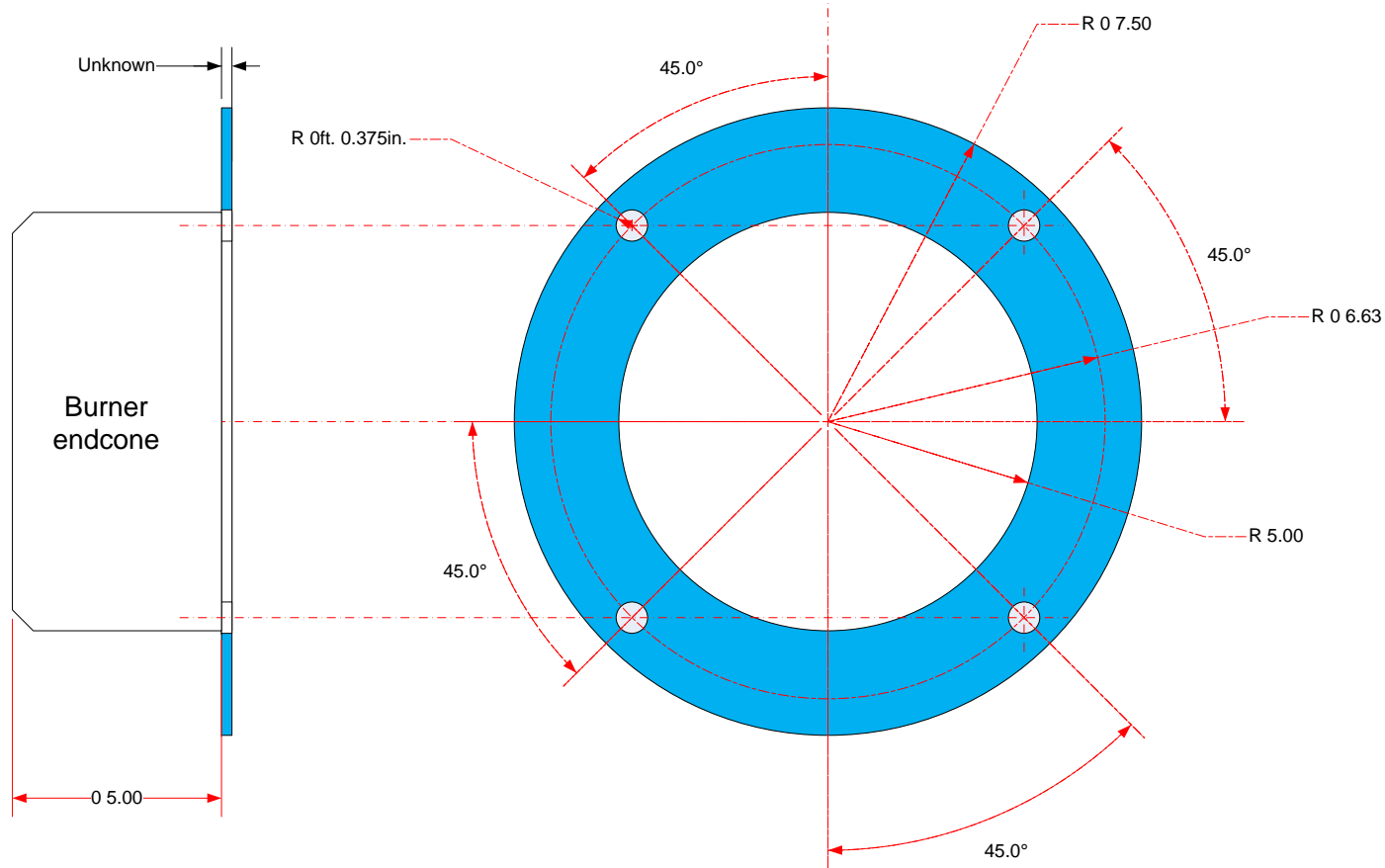

Drawing Template [0]	De Dietrich 		Description				Industrial Combustion burner model V-VL-VLG 35-55 Size 2 – Burner flange details for reference only	
	DDR Americas Inc. 1090 Fountain Street North, Unit 10 & 11 Cambridge, Ontario N3E 1A3 – Canada Tel: 1.800.943.6275 Fax: 519.650.1709 Website: www.dedietrichboilers.com		Creator	Craig H.	Tolerances ±	0.03"	Material	8259-0538
			Approved		Scale	3" = 1 ft.	File Name	2-500-ICB-002b
			Revision	0	Units	Inches	Date [mm/dd/yy]	04/30/08

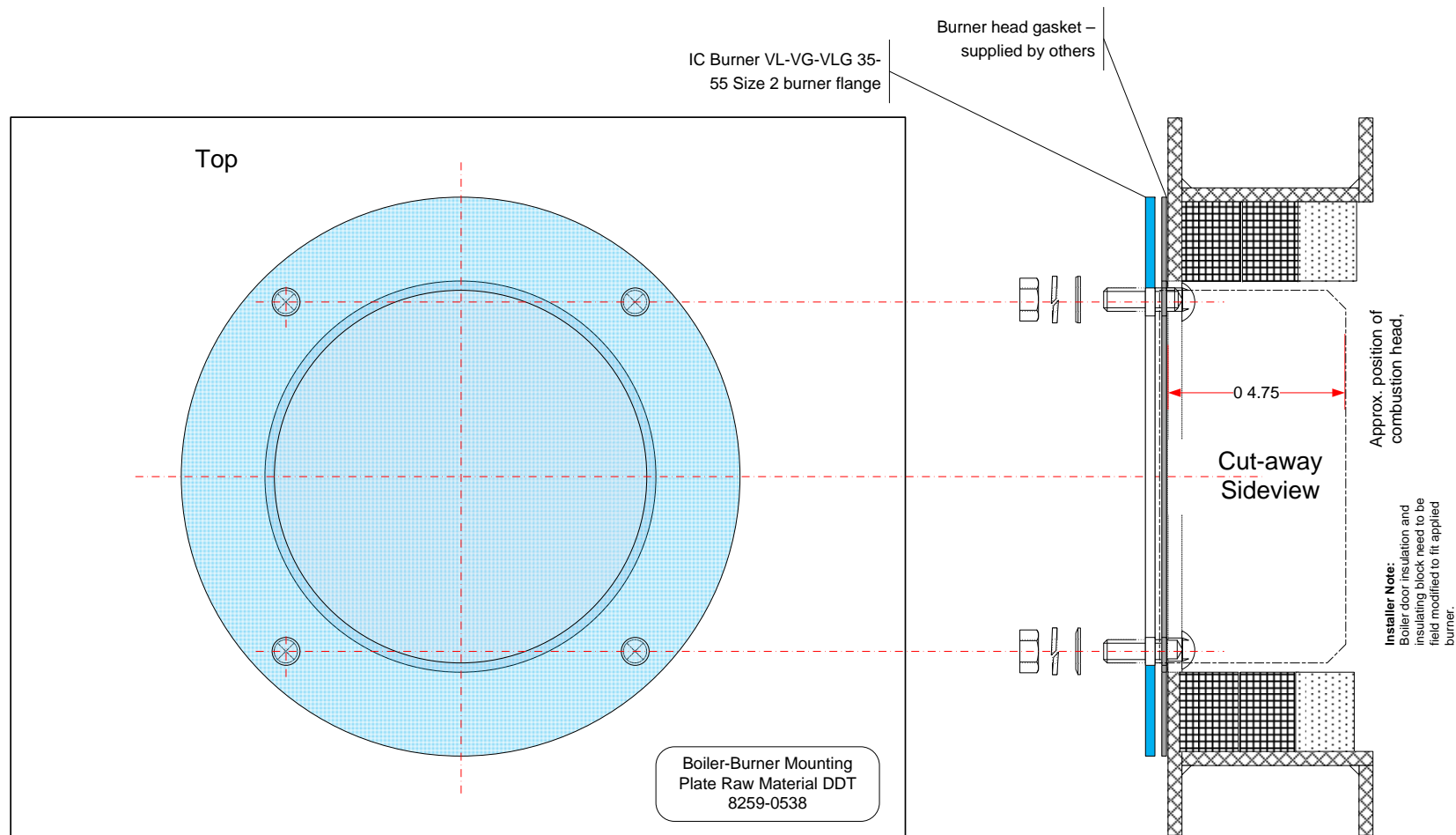

Drawing Template [0]	De Dietrich 		Description				Final Assembly drawing – reference only – GTE500A(GT530A) boiler door with IC VL-VG-VLG 35-55 Size 2 burners	
	Flexible Eutectic Boilers Ltd. [North America] 1090 Fountain Street North, Unit 10 & 11 Cambridge, Ontario N3E 1A3 – Canada Tel: 1.800.943.6275 Fax: 519.650.1709 Website: www.dedietrichboilers.com		Creator	Craig H.	Tolerances ±	0.03"	Material	8259-0538
			Approved		Scale	3" = 1 ft.	File Name	2-500-ICB-002c
			Revision	0	Units	Inches	Date [mm/dd/yy]	04/30/08